

ALU HALL (5m)



ALU HALL 5 METRES

The Alu Hall is a clearspan aluminium frame structure that comes in the following widths: 8, 10, 12, 15, 20 or 25 metres. The length is unlimited and can be extended by successive increments of 5 metres.

These concepts, which are based on a modular structure, are enhanced by a generous side wall height and solid PVC side panels. The panels can be replaced if desired by luxurious door units, emergency doors, attractive smoked glass windows or PVC curtains with decorative arched windows.

De Boer Alu Halls are made of a sturdy aluminium frame, covered by an exceedingly strong and fireproof PVC façade and roof covering. The structure can be erected very quickly. The Alu Hall can withstand most weather conditions.

THE IDEAL SOLUTION FOR EVERY SPACE PROBLEM

De Boer Alu Halls can be erected on nearly any terrain and this type of structure offers you an extremely efficient use of space. Owing to their rectangular shape, Alu Halls are suitable for multifunctional use.

This includes parties, exhibitions, company parties, car shows, temporary shops, storage space for covering a construction project and many more. Alu Halls of varying widths are often combined together. This is possible because these structures, like all other De Boer structures, can be linked. Wherever large areas have to be covered efficiently the De Boer Alu Hall is a logical and cost-efficient solution.

COMFORTABLE AND STRONG

The roof-tensioning system, developed and patented by De Boer, keeps the roof fabric taut under all conditions. This prevents annoying flapping and extraneous noise, which is another good reason why being inside a De Boer Alu Hall is so agreeable. Use of the hard PVC side panels creates a comfortable space; with perfect climate control. The apex of all Alu Hall structures has a unique system of natural ventilation developed by De Boer itself. De Boer has a wide range of options for lining and furnishing the structure.



CUCKOO FOR STILL BETTER VENTILATION

Another special De Boer development is the Cuckoo, which can be fitted to the roof of the Alu Hall. This is a type of raised ventilation grid that provides natural, enhanced extraction of air. This innovative and effective system ensures extra, draught free air circulation and a comfortable climate.

QUALITY AND SAFETY

Typical of all De Boer accommodation is the integrity and safety of all the materials and structures used. Structures meet stringent European requirements, including the German DIN standards. All materials meet the highest European standards for fire safety. All structures are wind tested. In this way De Boer ensures not only stylish accommodation but carefree hospitality as well.

De Boer International B.V.
Laanenderweg 11 1812 PW Alkmaar
P.O.Box 446 1800 AK Alkmaar
The Netherlands

Phone +31 (0) 72 750 11 00
Fax +31 (0) 72 750 11 99
www.deboer.com
international@deboer.com

Specifications may be altered without notification.
Copyright by De Boer International B.V..

ALU HALL 5 METRES



DE BOER COVERS ALL

ALU HALL 5 METRES



DE BOER COVERS ALL

ALU HALL 5 METRES

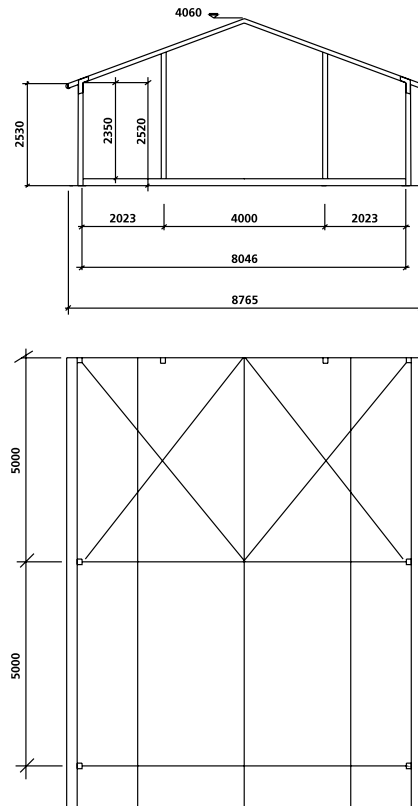

ALU HALL A08/ 250/ 5

SIDE PANELS	ROOF COVERS	GABLE FABRIC
White	White/ opaque (light-proof)	White/ opaque (light-proof)
White	White	White

If requested, the bearing capacity of the floor can be increased (plate floor 800/ 1000 kg and cassette floor 600/ 700 kg)

Structures available	With and without system floor	TECHNICAL SPECIFICATIONS	
Maximum bearing capacity, floor	500kg/m ²	Incline of roof	20°
Connection with other DB structures	Yes	Side wall height	2.530
Connection to buildings	Yes	Overall height	4.060
Awning available	Yes	Wind load	0,50KN/m ²
Wall lining/swags and pelmets available	Yes	Snow load	0KN/m ²
Optional replacement of wall bracing	Yes	Truss profile	120*120
Installation options for:		Roof tensioning system	Unique roll-up system
- Luxury synthetic door	Yes	Roof overhang	Yes
- Luxury pushbar/glass door	Yes	Performance calculations	Yes
- Smoked glass windows/ doors	Yes	German T.U.V. assessor	Yes
- Locking door	Yes	Valid assembly manual	Yes
- Emergency door	Yes		

ALU HALL 5 METRES

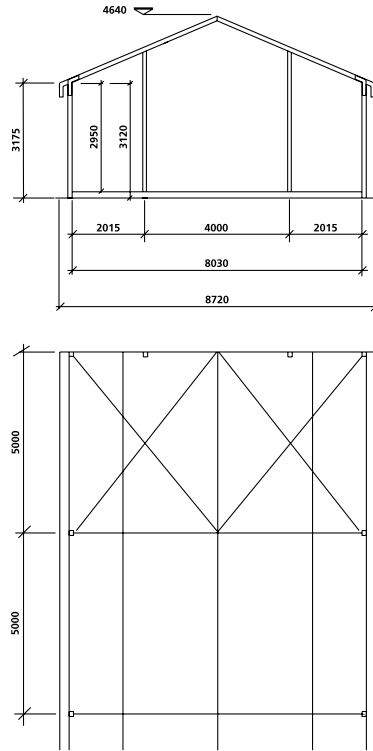

ALU HALL A08/ 325/ 5

SIDE PANELS	ROOF COVERS	GABLE FABRIC
White	White/ opaque (light-proof)	White/ opaque (light-proof)
White	White	White
If requested, the bearing capacity of the floor can be increased (plate floor 800/ 1000 kg and cassette floor 600/ 700 kg)		

Structures available	With and without system floor	TECHNICAL SPECIFICATIONS	
Maximum bearing capacity, floor	500kg/m ²	Incline of roof	20°
Connection with other DB structures	Yes	Side wall height	3.175
Connection to buildings	Yes	Overall height	4.640
Awning available	Yes	Wind load	0,50KN/m ²
Wall lining/swags and pelmets available	Yes	Snow load	0KN/m ²
Optional replacement of wall bracing	Yes	Truss profile	120*120
Installation options for:		Roof tensioning system	Unique roll-up system
- Luxury synthetic door	Yes	Roof overhang	Yes
- Luxury pushbar/glass door	Yes	Performance calculations	Yes
- Smoked glass windows/ doors	Yes	German T.U.V. assessor	Yes
- Locking door	Yes	Valid assembly manual	Yes
- Emergency door	Yes		

ALU HALL 5 METRES

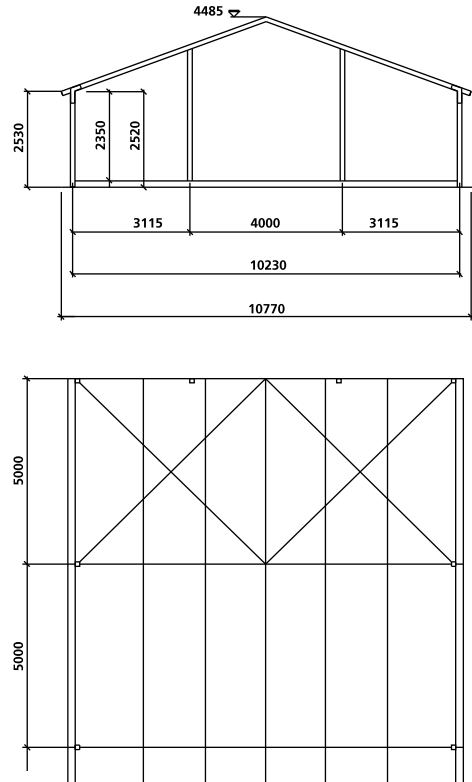

ALU HALL A10/ 250/ 5

SIDE PANELS	ROOF COVERS	GABLE FABRIC
White	White/ opaque (light-proof)	White/ opaque (light-proof)
White	White	White
If requested, the bearing capacity of the floor can be increased (plate floor 800/ 1000 kg and cassette floor 600/ 700 kg)		

Structures available	With and without system floor	TECHNICAL SPECIFICATIONS	
Maximum bearing capacity, floor	500kg/m ²	Incline of roof	20°
Connection with other DB structures	Yes	Side wall height	2.530
Connection to buildings	Yes	Overall height	4.485
Awning available	Yes	Wind load	0,50KN/m ²
Wall lining/swags and pelmets available	Yes	Snow load	0KN/m ²
Optional replacement of wall bracing	Yes	Truss profile	120*120
Installation options for:		Roof tensioning system	Unique roll-up system
- Luxury synthetic door	Yes	Roof overhang	Yes
- Luxury pushbar/glass door	Yes	Performance calculations	Yes
- Smoked glass windows/ doors	Yes	German T.U.V. assessor	Yes
- Locking door	Yes	Valid assembly manual	Yes
- Emergency door	Yes		

ALU HALL

A10_400_5

SIDE PANELS	ROOF COVERS
White	White / Opaque
	(light proof)

If requested, the bearing capacity of the floor can be increased (plate floor 800/ 1000 kg and cassette floor 600/ 700 kg)

Structures available	With and without system floor
Maximum bearing capacity floor	500kg/m ²
Connection with other DB structures	Yes
Connection to buildings	Yes
Awning available	Yes
Wall lining / swags and pelmets available	Yes
Installation options for:	
- Luxury synthetic door	Yes
- Luxury push bar/glass door	Yes
- Smoked glass windows	Yes
- PVC arched windows	Yes
- Locking door	Yes
- Emergency door	Yes

TECHNICAL SPECIFICATIONS

Incline of roof	18°
Side wall height	3770
Overall height	5700
Wind load	0.50kN/m ²
Snow load	0kN/m ²
Truss profile	120x200
Roof tensioning system	Unique roll-up system
Roof soverhang	Yes
Performance calculations	Yes
German T.U.V. assessor	Yes

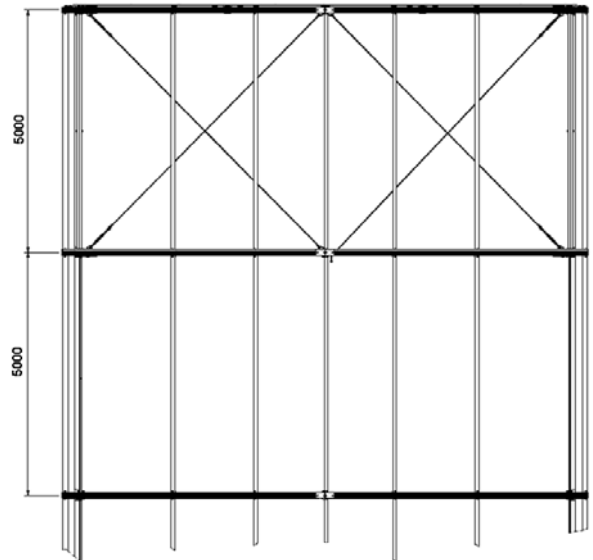
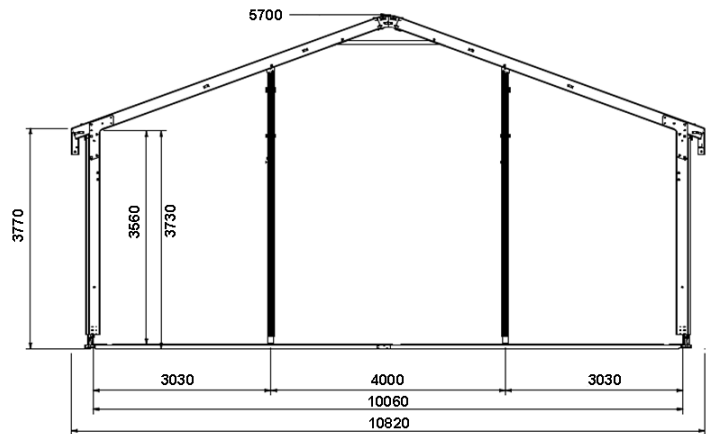

ALU HALL 5 METRES

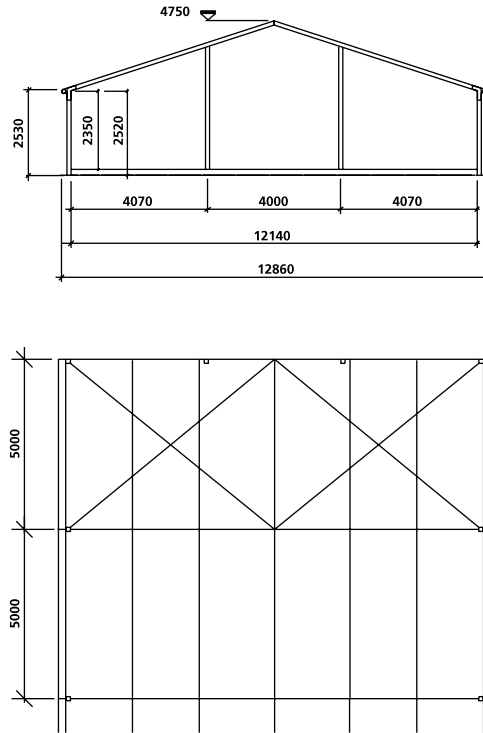

ALU HALL A12/ 250/ 5

SIDE PANELS	ROOF COVERS	GABLE FABRIC
White	White/ opaque (light-proof)	White/ opaque (light-proof)
White	White	White
If requested, the bearing capacity of the floor can be increased (plate floor 800/ 1000 kg and cassette floor 600/ 700 kg)		

Structures available	With and without system floor	TECHNICAL SPECIFICATIONS	
Maximum bearing capacity, floor	500kg/m ²	Incline of roof	20°
Connection with other DB structures	Yes	Side wall height	2.530
Connection to buildings	Yes	Overall height	4.750
Awning available	Yes	Wind load	0,50KN/m ²
Wall lining/swags and pelmets available	Yes	Snow load	0KN/m ²
Optional replacement of wall bracing	Yes	Truss profile	120*120
Installation options for:		Roof tensioning system	Unique roll-up system
- Luxury synthetic door	Yes	Roof overhang	Yes
- Luxury pushbar/glass door	Yes	Performance calculations	Yes
- Smoked glass windows/ doors	Yes	German T.U.V. assessor	Yes
- Locking door	Yes	Valid assembly manual	Yes
- Emergency door	Yes		

ALU HALL 5 METRES

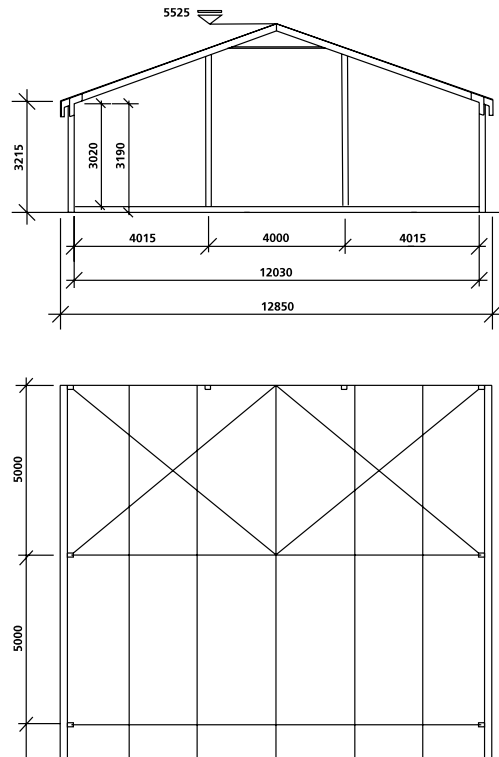

ALU HALL A12/ 325/ 5

SIDE PANELS

White

White

ROOF COVERS

White/ opaque (light-proof)

White

GABLE FABRIC

White/ opaque (light-proof)

White

If requested, the bearing capacity of the floor can be increased (plate floor 800/ 1000 kg and cassette floor 600/ 700 kg)

Structures available	With and without system floor	TECHNICAL SPECIFICATIONS	
Maximum bearing capacity, floor	500kg/m ²	Incline of roof	18°
Connection with other DB structures	Yes	Side wall height	3.215
Connection to buildings	Yes	Overall height	5.525
Light- proof fabric available	Yes	Wind load	0,50KN/m ²
Awning available	Yes	Snow load	0KN/m ²
Wall lining/swags and pelmets available	Yes	Truss profile	120*200
Optional replacement of wall bracing	Yes	Roof tensioning system	Unique roll-up system
Installation options for:		Roof overhang	Yes
- Luxury synthetic door	Yes	Performance calculations	Yes
- Luxury pushbar/glass door	Yes	German T.U.V. assessor	Yes
- Smoked glass windows/ doors	Yes	Valid assembly manual	Yes
- Locking door	Yes		
- Emergency door	Yes		

ALU HALL 5 METRES

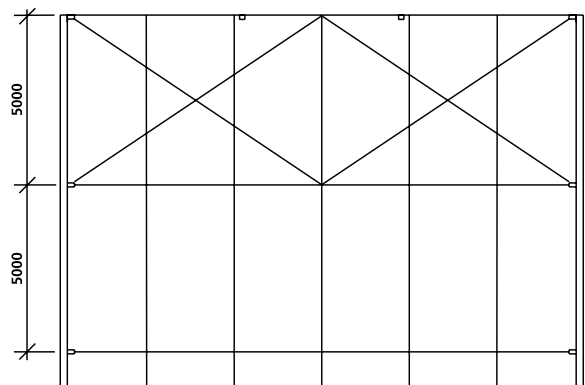
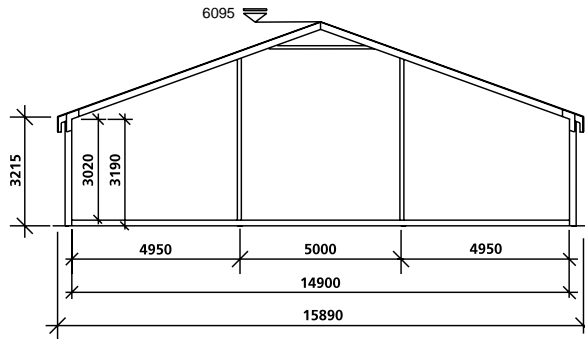

ALU HALL A15/ 325/ 5

SIDE PANELS	ROOF COVERS	GABLE FABRIC
White	White/ opaque (light-proof)	White/ opaque (light-proof)
White	White	White
If requested, the bearing capacity of the floor can be increased (plate floor 800/ 1000 kg and cassette floor 600/ 700 kg)		

Structures available	With and without system floor	TECHNICAL SPECIFICATIONS	
Maximum bearing capacity, floor	500kg/m ²	Incline of roof	20°
Connection with other DB structures	Yes	Side wall height	3.215
Connection to buildings	Yes	Overall height	6.095
Light- proof fabric available	Yes	Wind load	0,50KN/m ²
Awning available	Yes	Snow load	0KN/m ²
Wall lining/swags and pelmets available	Yes	Truss profile	120*200
Optional replacement of wall bracing	Yes	Roof tensioning system	Unique roll-up system
Installation options for:		Roof overhang	Yes
- Luxury synthetic door	Yes	Performance calculations	Yes
- Luxury pushbar/glass door	Yes	German T.U.V. assessor	Yes
- Smoked glass windows/ doors	Yes	Valid assembly manual	Yes
- Locking door	Yes		
- Emergency door	Yes		

ALU HALL 5 METRES

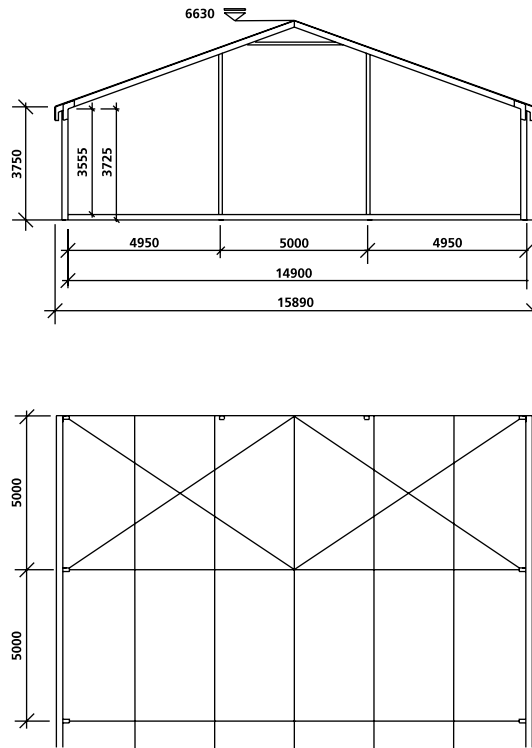

ALU HALL A15/ 375/ 5

SIDE PANELS	ROOF COVERS	GABLE FABRIC
White	White/ opaque (light-proof)	White/ opaque (light-proof)
White	White	White
If requested, the bearing capacity of the floor can be increased (plate floor 800/ 1000 kg and cassette floor 600/ 700 kg)		

Structures available	With and without system floor	TECHNICAL SPECIFICATIONS	
Maximum bearing capacity, floor	500kg/m ²	Incline of roof	20°
Connection with other DB structures	Yes	Side wall height	3.750
Connection to buildings	Yes	Overall height	6.630
Light- proof fabric available	Yes	Wind load	0,50KN/m ²
Awning available	Yes	Snow load	0KN/m ²
Wall lining/swags and pelmets available	No	Truss profile	120*200
Optional replacement of wall bracing	No	Roof tensioning system	Unique roll-up system
Arched windows available	No	Roof overhang	Yes
Installation options for:		Performance calculations	Yes
- Luxury synthetic door	Yes	German T.U.V. assessor	Yes
- Luxury pushbar/glass door	Yes	Valid assembly manual	Yes
- Smoked glass windows/ doors	Yes		
- Locking door	Yes		
- Emergency door	Yes		

ALU HALL 5 METRES

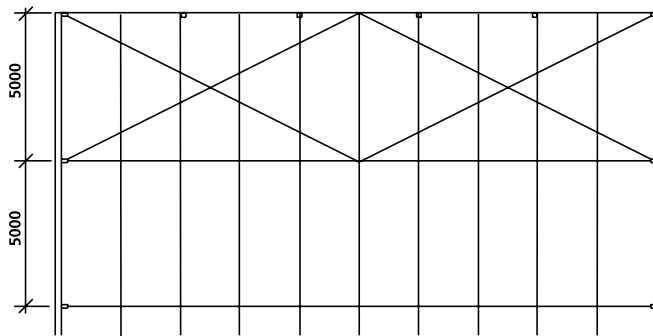
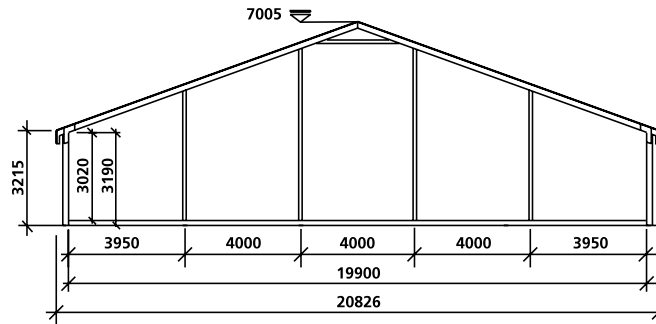

ALU HALL A20/ 325/ 5

SIDE PANELS

White

White

ROOF COVERS

White/ opaque (light-proof)

White

GABLE FABRIC

White/ opaque (light-proof)

White

If requested, the bearing capacity of the floor can be increased (plate floor 800/ 1000 kg and cassette floor 600/ 700 kg)

Structures available	With and without system floor
Maximum bearing capacity, floor	500kg/m ²
Connection with other DB structures	Yes
Connection to buildings	Yes
Light- proof fabric available	Yes
Awning available	Yes
Wall lining/swags and pelmets available	Yes
Optional replacement of wall bracing	Yes
Installation options for:	
- Luxury synthetic door	Yes
- Luxury pushbar/glass door	Yes
- Smoked glass windows/ doors	Yes
- Locking door	Yes
- Emergency door	Yes

TECHNICAL SPECIFICATIONS

Incline of roof	20°
Side wall height	3.215
Overall height	7.005
Wind load	0,50KN/m ²
Snow load	0KN/m ²
Truss profile	120*200
Roof tensioning system	Unique roll-up system
Roof overhang	Yes
Performance calculations	Yes
German T.U.V. assessor	Yes
Valid assembly manual	Yes

ALU HALL 5 METRES

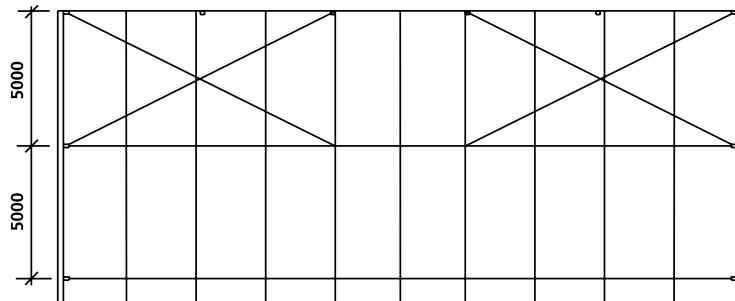
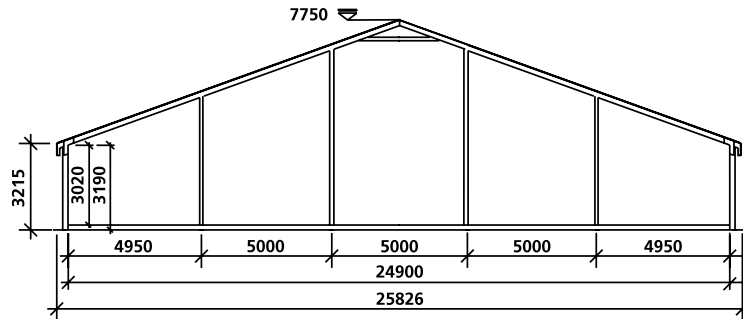

ALU HALL A25/ 325/ 5

SIDE PANELS

White

White

ROOF COVERS

White/ opaque (light-proof)

White

GABLE FABRIC

White/ opaque (light-proof)

White

If requested, the bearing capacity of the floor can be increased (plate floor 800/ 1000 kg and cassette floor 600/ 700 kg)

Structures available	With and without system floor
Maximum bearing capacity, floor	500kg/m ²
Connection with other DB structures	Yes
Connection to buildings	Yes
Light- proof fabric available	Yes
Awning available	Yes
Wall lining/swags and pelmets available	Yes
Optional replacement of wall bracing	Yes
Installation options for:	
- Luxury synthetic door	Yes
- Luxury pushbar/glass door	Yes
- Smoked glass windows/ doors	Yes
- Locking door	Yes
- Emergency door	Yes

TECHNICAL SPECIFICATIONS

Incline of roof	18°
Side wall height	3.215
Overall height	7.750
Wind load	0,50KN/m ²
Snow load	0KN/m ²
Truss profile	120*200
Roof tensioning system	Unique roll-up system
Roof overhang	Yes
Performance calculations	Yes
German T.U.V. assessor	Yes
Valid assembly manual	Yes